

JUST



STILTEK



STILTEK
TERAMO - ITALY

STILTEK

L'AZIENDA
THE COMPANY

UN'AZIENDA AL SERVIZIO DEGLI ARREDATORI

Stiltek è una divisione del Gruppo Frigomeccanica ed ha sede in provincia di Teramo, nell'Italia Centrale. Stiltek è un'industria dotata di macchinari di ultima generazione per la lavorazione dei metalli ed ha per oggetto specifico la produzione di un'ampia gamma di moduli refrigerati e neutri quali componenti tecnologici per l'arredamento di attività commerciali (bar, gelaterie, pasticcerie). La produzione Stiltek, realizzata interamente con tubolari di alluminio e lamiere di acciaio inox, è molto flessibile, ben si adatta ad ogni esigenza ed è garanzia di assoluta durata nel tempo. I moduli Stiltek sono la soluzione ideale per quanti progettano e realizzano arredi per pubblici esercizi ed intendono concretizzare le loro idee completando i moduli Stiltek con pannellature e finiture di ogni genere.

FOUNDED TO SERVE INTERIOR DESIGNERS

Stiltek is a Frigomeccanica division based at Mosciano Sant'Angelo (Teramo, Italy). Stiltek is an industrial outfit equipped with latest-generation metal-working machinery and was specifically founded to produce a wide range of refrigerated and non-refrigerated modules for supply as technological components in the interior designs of business premises (bars, ice-cream parlours and patisseries). Stiltek's output, made entirely from tubular aluminium and sheet stainless steel, is highly flexible, adapting easily to all requirements, and assures absolute durability. Stiltek modules are the ideal solution for those who design and produce furnishings for public venues, who can realise their designs by completing Stiltek modules with panelling and finishes of all kinds.



JUST /



PRALINERIA
CHOCOLATE



PASTICCERIA
CONFECTIONERY



GASTRONOMIA
CALDA
WARM FOOD



GASTRONOMIA
FREDDA
COLD FOOD

JUST

IT_ Just è una linea completa e versatile di vetrine refrigerate, neutre, calde e calde/fredde, studiate appositamente per snack, pasticceria, pralineria e gastronomia, caratterizzate da illuminazione a led inserita nei profili laterali e in alto. Questo permette un'eccellente illuminazione dei piani espositivi. Una gamma di moduli lineari di varie lunghezze e angoli, tutti canalizzabili fra loro, disponibili in diverse altezze.

EN_ Just is a complete and versatile line of refrigerated, neutral, hot and hot/cold showcases, properly studied for snack, pastry, confectionery and gastronomy, characterized from the led illumination inserted into the side profiles and on the top, that permits an excellent illumination of the exposure plans. A wide range of linear modules of different lengths and angles, all ductable together and available in different heights.

JUST

VETRINA A VETRI BASSI DRITTI
LOW STRAIGHT GLASS SHOWCASE



JUST

VETRINA A VETRI
BASSI DRITTI
LOW STRAIGHT
GLASS SHOWCASE

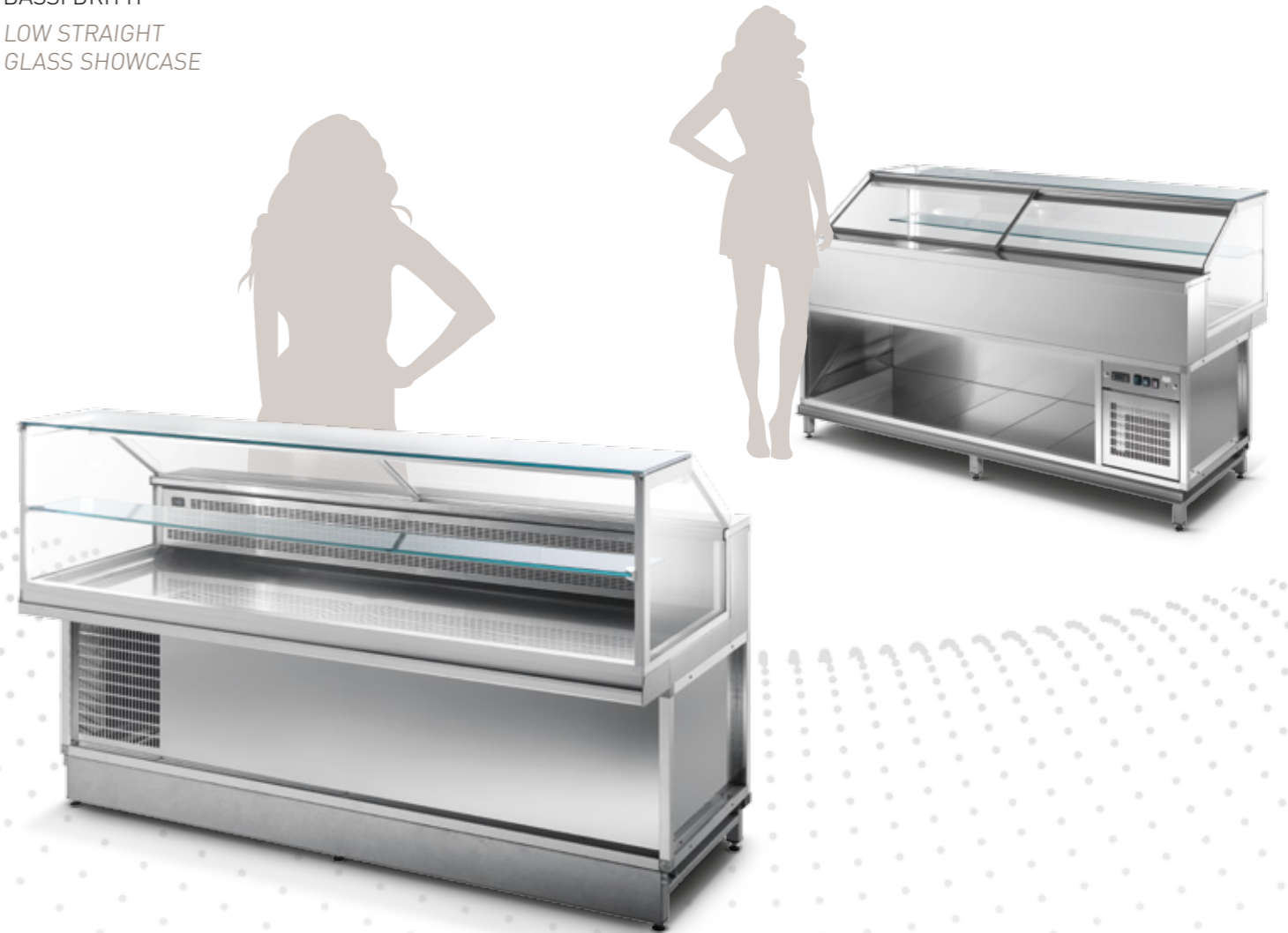

JUST VETRINA A VETRI BASSI DRITTI
LOW STRAIGHT GLASS SHOWCASE



IT_ Vetrina Snack refrigerata. Struttura portante in tubolare di alluminio anodizzato con ripiano e piedi regolabili. Piano espositivo monoscocca in poliuretano iniettato alla densità di 38/40 kg/mc ed acciaio inox AISI 304 finitura scotch brite e bordi raggianti. Vetri dritti alti/bassi con montanti laterali e plafoniera in alluminio. Illuminazione a led sui montanti e sulla plafoniera. Chiusura posteriore in plexiglass su guide scorrevoli. Sistema anticondensa sul vetro con resistenza a comando. Impianto refrigerante statico con capillare se il motore è interno, con valvola termostatica in caso di motore esterno. Sbrinamento automatico con termostato elettronico, resistenza elettrica e sonda di fine sbrinamento.

Classe climatica 3 (25°- 60% U.R.).
Temperatura di esercizio +3°+7°C.
Optional: kit bassa ventilazione.
Piano caldo a secco con termostato.
Mensola calda con termostato.
Cella a cassettoni estraibili.

EN_ Refrigerated Snack Showcase for Confectionery. Tubular anodised aluminium structure with shelf and adjustable feet. Enbloc display top in injected polyurethane with density 38/40 Kg/m3, and Scotch brite finish AISI 304 stainless steel with rounded edges. High/low tempered glass with aluminium side uprights and top light. LED lighting on uprights and top. Sliding Plexiglas rear door. Glass anti-misting system with heating element controlled by on-off switch. Static refrigeration system with capillary tube if motor is integral, with thermostat valve if motor is external. Automatic defrosting with electronic thermostat, electric heating element and defrosting end probe.

Climate class 3 (25°C-60% R.H.)
Operating temperature +3°+7° C.
Optional: low-level fan kit.
Dry hot table with thermostat.
Heated plate with thermostat.
Cell with extractable drawers.

COLORI STRUTTURA / COLOUR OF THE STRUCTURE OF THE GLASS:

-  Anodizzazione Nero / Black
-  Anodizzazione Argento / Silver

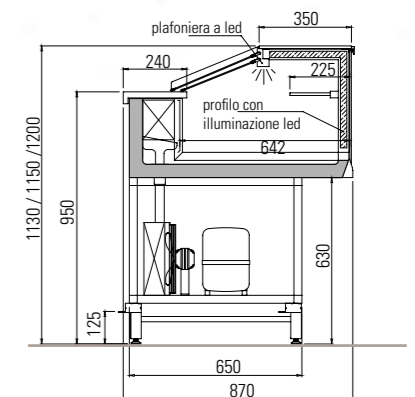

LUNGHEZZE MM.	1000	1250	1500	2000
LENGHTS MM.				

JUST

VETRINA A VETRI ALTI
DRITTIHIGH STRAIGHT
GLASS SHOWCASE

JUST

VETRINA A VETRI ALTI DRITTI
HIGH STRAIGHT GLASS SHOWCASE



IT_ Vetrina Snack refrigerata. Struttura portante in tubolare di alluminio anodizzato con ripiano e piedi regolabili. Piano espositivo monoscocca in poliuretano iniettato alla densità di 38/40 kg/mc ed acciaio inox AISI 304 finitura scotch brite e bordi raggianti. Vetri dritti alti/bassi con montanti laterali e plafoniera in alluminio. Illuminazione a led sui montanti e sulla plafoniera. Chiusura posteriore in plexiglass su guide scorrevoli. Sistema anticondensa sul vetro con resistenza a comando. Impianto refrigerante statico con capillare se il motore è interno, con valvola termostatica in caso di motore esterno. Sbrinamento automatico con termostato elettronico, resistenza elettrica e sonda di fine sbrinamento.

Classe climatica 3 (25°- 60% U.R.).
Temperatura di esercizio +3°+7°C.
Optional: kit bassa ventilazione.
Piano caldo a secco con termostato.
Mensola calda con termostato.
Cella a cassette estraibili.

LUNGHEZZE MM.	1000	1250	1500	2000
LENGHTS MM.				

EN_ Refrigerated Snack Showcase for Confectionery. Tubular anodised aluminium structure with shelf and adjustable feet. Enbloc display top in injected polyurethane with density 38/40 Kg/m3, and Scotch brite finish AISI 304 stainless steel with rounded edges. High/low tempered glass with aluminium side uprights and top light. LED lighting on uprights and top. Sliding Plexiglas rear door. Glass anti-misting system with heating element controlled by on-off switch. Static refrigeration system with capillary tube if motor is integral, with thermostat valve if motor is external. Automatic defrosting with electronic thermostat, electric heating element and defrosting end probe.

Climate class 3 (25°C-60% R.H.) .
Operating temperature +3°+7° C.
Optional: low-level fan kit.
Dry hot table with thermostat.
Cell with extractable drawers.

COLORI STRUTTURA / COLOUR OF THE STRUCTURE OF THE GLASS:

- Anodizzazione Nero / Black
- Anodizzazione Argento / Silver

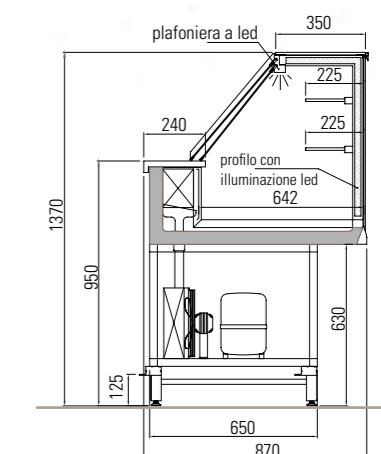

JUST

VETRINA CALDA CON VETRI ALTI DRITTI

HOT SHOWCASE WITH HIGH STRAIGHT GLASS

IT_ CALDA A BAGNO MARIA

Struttura portante in tubolare di alluminio anodizzato con ripiano e piedini regolabili. Vetri dritti alti/bassi temprati con montanti laterali e plafoniera in alluminio. Illuminazione a led sui montanti e sulla plafoniera. Chiusura posteriore in plexiglass su guide scorrevoli. Impianto idrico con carico e scarico manuale e rubinetti di chiusura, vasca bagnomaria in acciaio inox AISI 304, sistema di riscaldamento con resistenze elettriche a contatto. Quadro comandi con termostato elettronico per il controllo dell'illuminazione e della temperatura. La vetrina calda bagnomaria è predisposta per l'inserimento delle vaschette gastronorm che il piano forato. Temperatura di esercizio +60°+70°C.

EN_ HOT WATER BATH

Tubular anodised aluminium structure with shelf and adjustable feet. Straight high/low tempered glass with aluminium side uprights and top light. LED lighting on uprights and top. Sliding Plexiglas rear door. Water system filled and drained by hand with stop-tap, AISI 304 stainless steel bain-marie well, heating by means of contact electrical elements. Control panel with electronic thermostat, for control of lighting and temperature. The bain-marie heated showcase is fitted to take either Gastronorm trays or a perforated shelf. Operating Temperature +60°+70° C.



IT_ CALDA A SECCO

Struttura portante in tubolare di alluminio anodizzato con ripiano e piedini regolabili. Vetri dritti alti/bassi temprati con montanti laterali e plafoniera in alluminio. Illuminazione a led sui montanti e sulla plafoniera. Chiusura posteriore in plexiglass su guide scorrevoli. Piano espositivo in acciaio inox AISI 304 con sistema di riscaldamento mediante le resistenze elettriche a contatto. Quadro comandi con termostato elettronico per il controllo dell'illuminazione e della temperatura. Temperatura di esercizio +60°+70°C.

EN_ DRY HOT

Tubular anodised aluminium structure with shelf and adjustable feet. Straight high/low tempered glass with aluminium side uprights and top light. LED lighting on uprights and top. Sliding Plexiglas rear door. AISI 304 stainless steel display top, heating by means of contact electrical elements. Control panel with electronic thermostat, for control of lighting and temperature. Operating temperature +60°+70° C.

COLORI STRUTTURA / COLOUR OF THE STRUCTURE OF THE GLASS:

-  Anodizzazione Nero / Black
-  Anodizzazione Argento / Silver

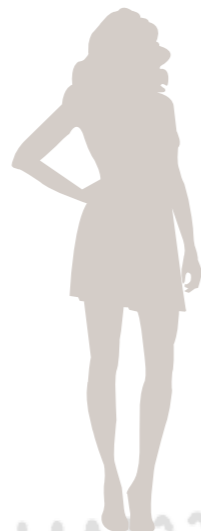

CALDA A BAGNO MARIA

HOT WATER BATH



CALDA A SECCO CON PIANO IN VETRO

DRY HOT WITH GLASS PLATE



CALDA A SECCO CON PIANO IN ACCIAIO

DRY HOT WITH STAINLESS STEEL PLAN

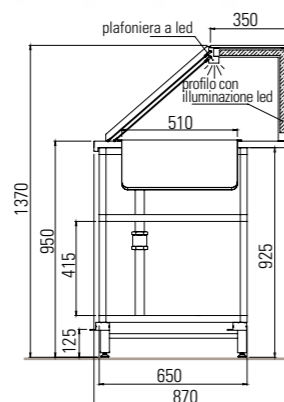

Calda a bagno maria con piano forato
Hot water bath with perforated top

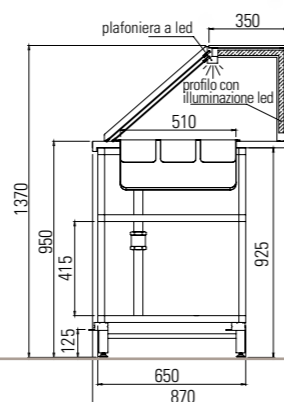

Calda a bagno maria Con vaschette
Hot water bath with trays

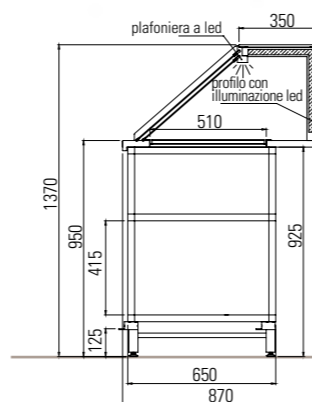

Calda a secco
Dry hot

LUNGHEZZE MM. LENGTHS MM.	1000	1250	1500	2000
------------------------------	------	------	------	------



JUST

VETRINA CALDA CON VETRI ALTI DRITTI
HOT SHOWCASE WITH HIGH STRAIGHT GLASS



JUST

VETRINA AD ANGOLO 90° VETRI DRITTI
90° ANGLE SHOWCASE WITH STRAIGHT GLASS

JUST

VETRINA AD ANGOLO
90° VETRI DRITTI

90° ANGLE
SHOWCASE WITH
STRAIGHT GLASS

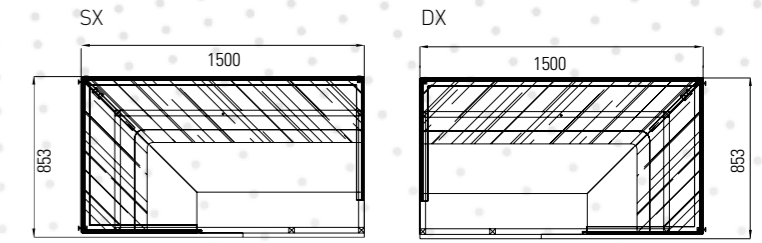

IT_ Vetrina Snack refrigerata. Struttura portante in tubolare di alluminio anodizzato con ripiano e piedi regolabili. Piano espositivo monoscocca in poliuretano iniettato alla densità di 38/40 kg/mc ed acciaio inox AISI 304 finitura scotch brite e bordi raggati. Vetri dritti alti/bassi con montanti laterali e plafoniera in alluminio. Illuminazione a led sui montanti e sulla plafoniera. Chiusura posteriore in plexiglass su guide scorrevoli. Sistema anticondensa sul vetro con resistenza a comando. Impianto refrigerante statico bassa ventilazione e con capillare se il motore è interno, con valvola termostatica in caso di motore esterno. Sbrinamento automatico con termostato elettronico, resistenza elettrica e sonda di fine sbrinamento.

Classe climatica 3 (25°- 60% U.R.).
Temperatura di esercizio +3°+7°C.
Optional:
Piano caldo a secco con termostato.
Mensola calda con termostato.

EN_ Refrigerated Snack Showcase for Confectionery. Tubular anodised aluminium structure with shelf and adjustable feet. Enbloc display top in injected polyurethane with density 38/40 Kg/m3, and Scotch brite finish AISI 304 stainless steel with rounded edges. High/low tempered glass with aluminium side uprights and top light. LED lighting on uprights and top. Sliding Plexiglas rear door. Glass anti-misting system with heating element controlled by on-off switch. Static refrigeration system with capillary tube if motor is integral, with thermostat valve if motor is external. Automatic defrosting with electronic thermostat, electric heating element and defrosting end probe.

Climate class 3 (25°C-60% R.H.) .
Operating temperature +3°+7° C.
Optional:
Dry hot table with thermostat.
Heated plate with thermostat.

COLORI STRUTTURA / COLOUR OF THE STRUCTURE OF THE GLASS:

- Anodizzazione Nero / Black
- Anodizzazione Argento / Silver

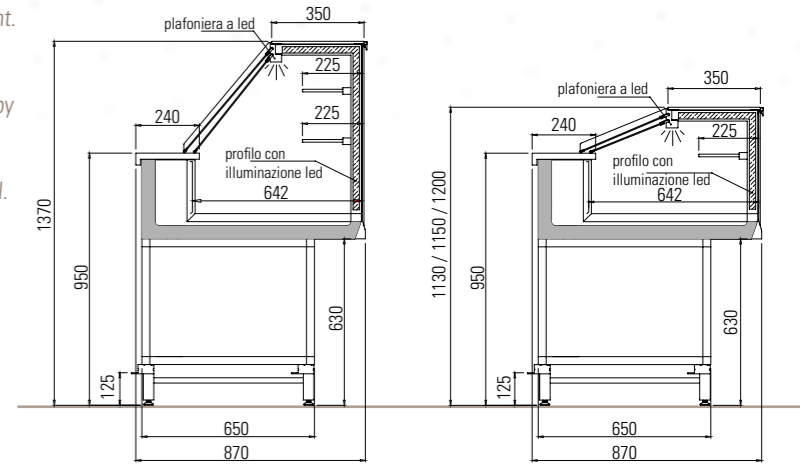

JUST VETRINA AD ANGOLO 90° VETRI DRITTI
90° ANGLE SHOWCASE WITH STRAIGHT GLASS

JUST

VETRINA REFRIGERATA PRALINERIA/CIOCCOLATO
A VETRI DRITTI ALTI E BASSI
CHOCOLATE/CONFECTIONERY REFRIGERATED
SHOWCASE WITH LOW/HIGH STRAIGHT GLASS

JUST
PRALINERIA
CONFECTIONERY

VETRINA REFRIGERATA
PRALINERIA/CIOCCOLATO
A VETRI DRITTI ALTI E
BASSI

REFRIGERATED
CHOCOLATE/
CONFECTIONERY
SHOWCASE
WITH LOW/HIGH
STRAIGHT GLASS

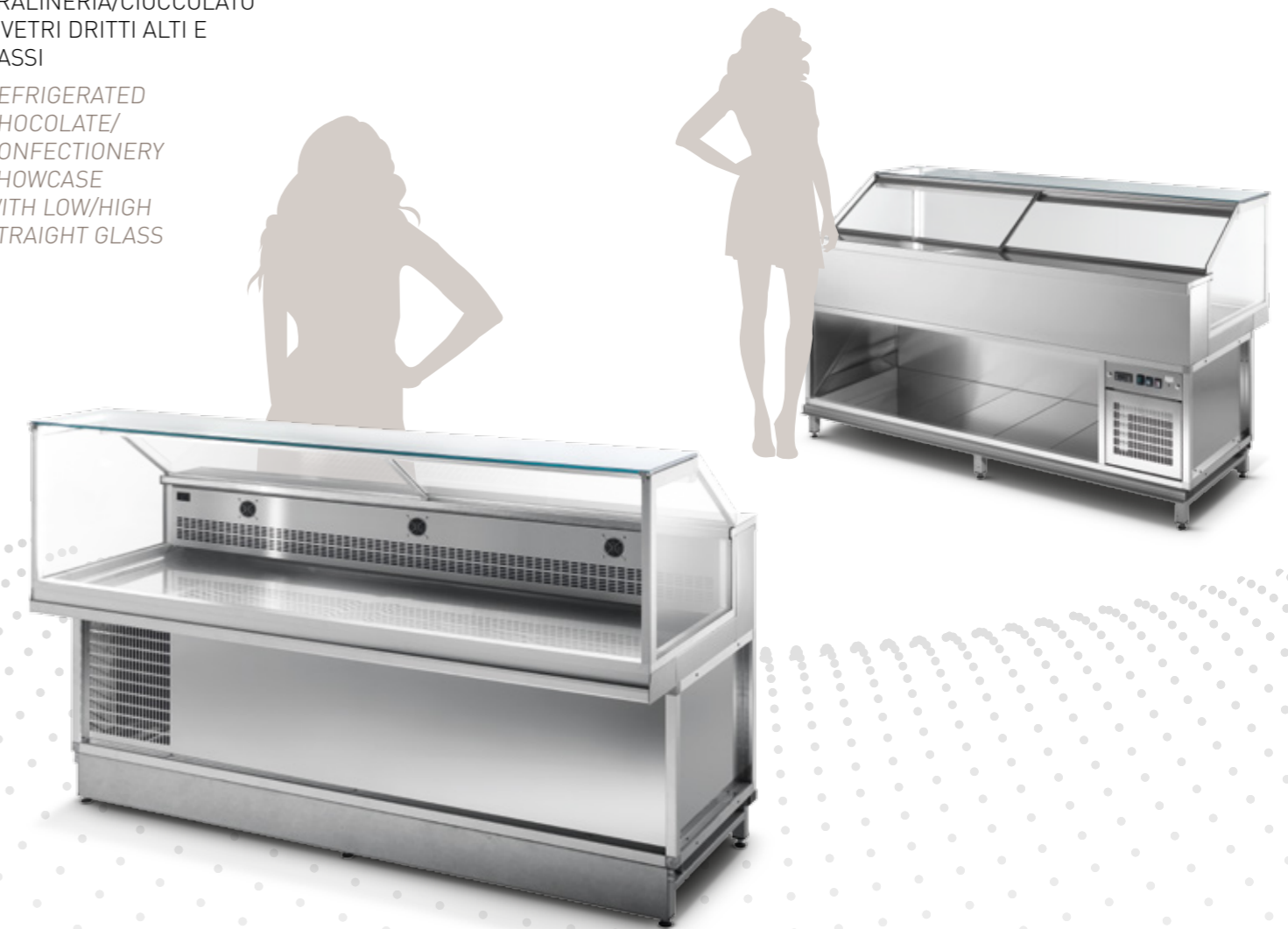

JUST

VETRINA REFRIGERATA PRALINERIA/CIOCCOLATO
A VETRI DRITTI ALTI E BASSI
CHOCOLATE/CONFECTIONERY REFRIGERATED
SHOWCASE WITH LOW/HIGH STRAIGHT GLASS

IT_ Vetrina per pralineria/cioccolato refrigerata. Struttura portante in tubolare di alluminio anodizzato con ripiano e piedi regolabili. Piano espositivo monoscocca in poliuretano iniettato alla densità di 38/40 kg/mc ed acciaio inox AISI 304 finitura scotch brite e bordi raggati. Vetri dritti alti/bassi con montanti laterali e plafoniera in alluminio. Illuminazione a led sui montanti e sulla plafoniera. Chiusura posteriore in plexiglass su guide scorrevoli. Sistema anticondensa sul vetro con resistenza a comando. Sbrinamento automatico con termostato elettronico, resistenza elettrica e sonda di fine sbrinamento.

Classe climatica 3(25°- 60% U.R.).
Temperatura di esercizio +14°+16°C
U.R.55/60%

EN_ Refrigerated chocolate/confectionery for Confectionery. Tubular anodised aluminium structure with shelf and adjustable feet. Enbloc display top in injected polyurethane with density 38/40 Kg/m3, and Scotch brite finish AISI 304 stainless steel with rounded edges. High/low tempered glass with aluminium side uprights and top light. LED lighting on uprights and top. Sliding Plexiglas rear door. Glass anti-misting system with heating element controlled by on-off switch. Automatic defrosting with electronic thermostat, electric heating element and defrosting end probe.

Climate class 3 (25°C-60% R.H.) Operating temperature +14°+16°C
U.R. 55/60%

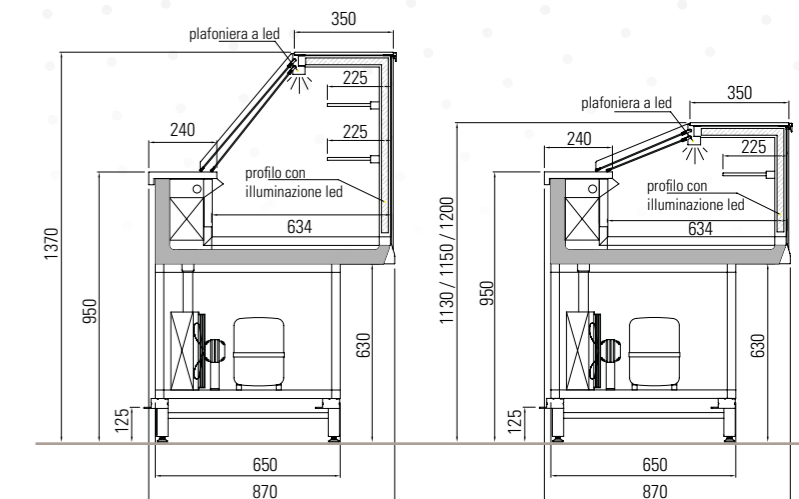

LUNGHEZZE MM. LENGHTS MM.	1000	1250	1500	2000
------------------------------	------	------	------	------

JUST
KIT BASSA VENTILAZIONE

LOW VENTILATION KIT

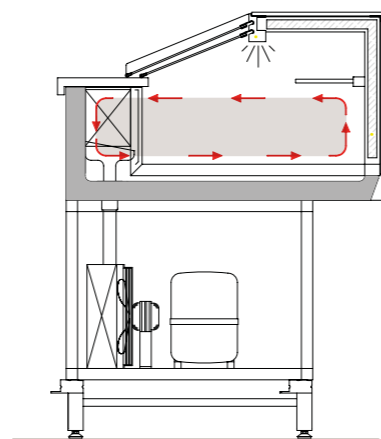

CELLA A CASSETTONI
ESTRAIBILI,
CON TEMPERATURA
INDIPENDENTE

CELL WITH EXTRACTABLE DRAWERS,
WITH INDEPENDENT TEMPERATURE

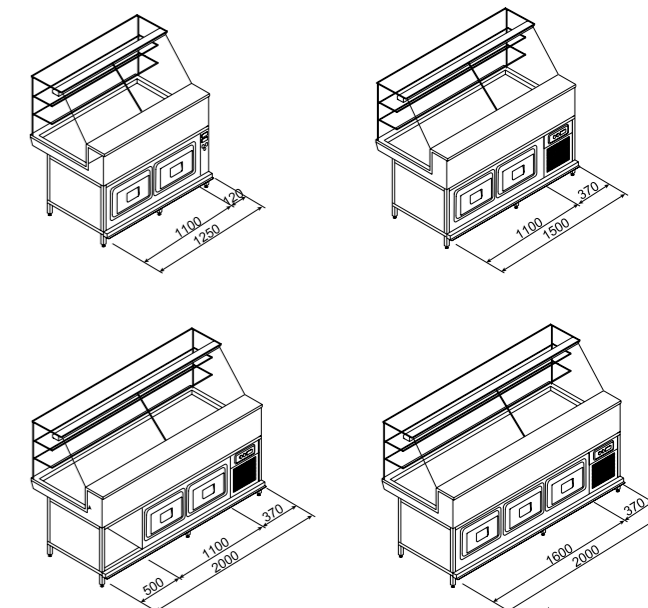

LUNGHEZZA/ LENGHT	MOTORE/ ENGINE
125	ME
150	MI / ME
200/2	MI / ME
200/3	MI / ME

* MI= motore interno / internal motor
ME= motore esterno / external motor



STILTEK



PIANI AGGIUNTIVI
ACCIAIO
RIVESTITO NERO

ADDITIONAL PLANS IN STAINLESS
STEEL COVERED IN BLACK

DETTAGLI TECNICI
/ TECHNICAL FEATURES

STILTEK

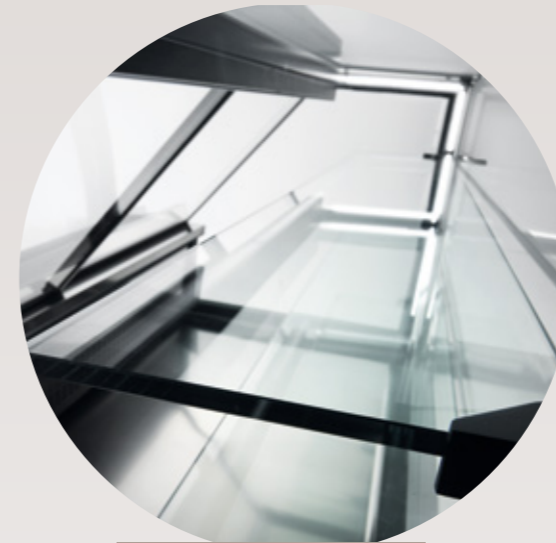

MENSOLA CALDA CON
TEMPERATURA REGOLABILE
(OPTIONAL)

HEATED PLATE WITH
ADJUSTABLE TEMPERATURE
(OPTIONAL)



PIANO CALDO A SECCO CON
TEMPERATURA REGOLABILE
(OPTIONAL)

DRY HOT TABLE WITH
ADJUSTABLE TEMPERATURE
(OPTIONAL)



VETRO CON DISAPPANNAMENTO
A COMANDO

GLASS WITH DEMISTING
ON COMMAND



DOPPIA PLAFONIERA A LED
LATERALE E SUPERIORE

DOUBLE LED CEILING LIGHT
ON SIDES AND ON THE TOP

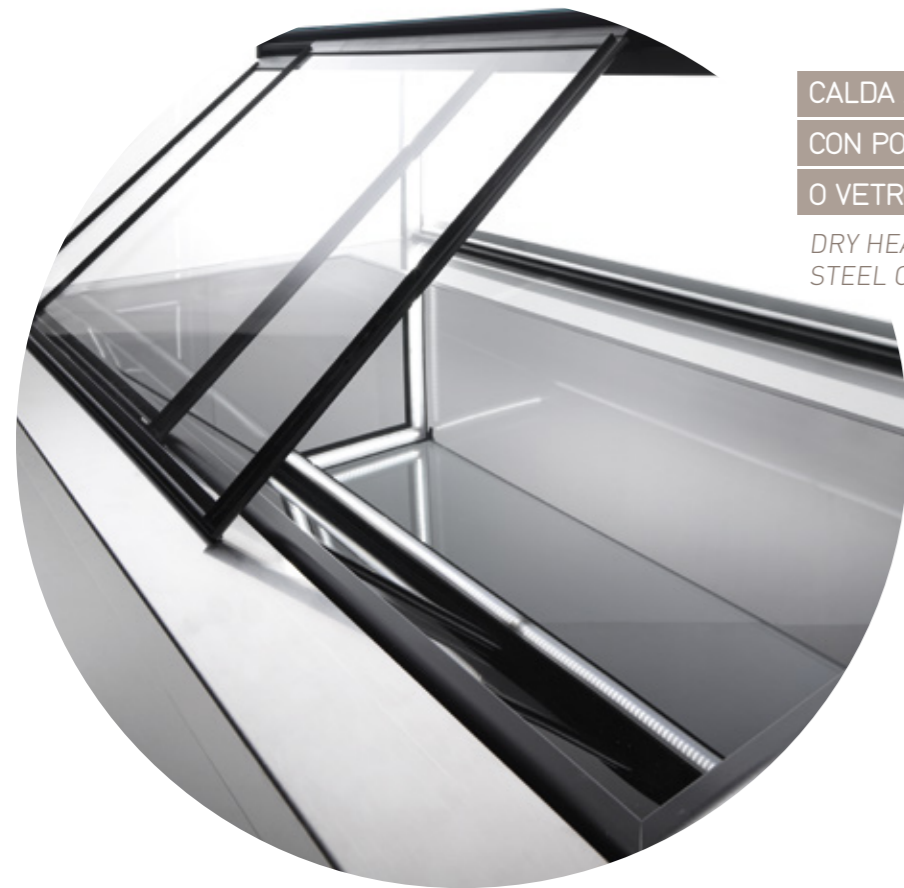

CALDA A SECCO
CON POSSIBILITÀ DI PIANO INOX
O VETRO NERO

DRY HEAT WITH THE POSSIBLTY OF STAINLESS
STEEL OR BLACK COVERED PLAN

CANALIZZAZIONE VETRINE
DUCTABLE SHOWCASES

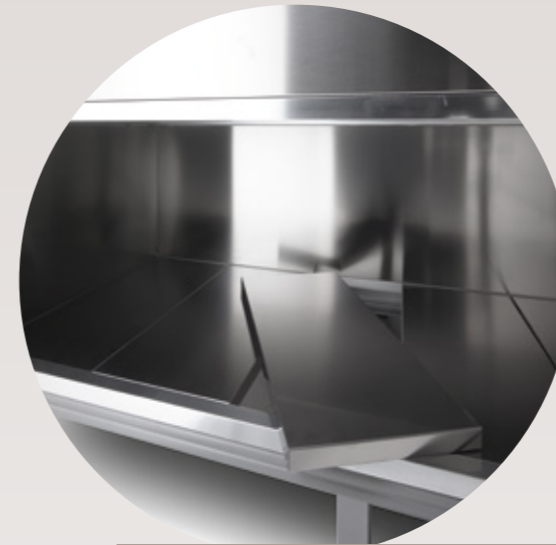

PIANI IN ACCIAIO INOX REMOVIBILI

REMOVABLE STAINLESS STEEL PLANS



ANGOLO RAGGIATO

REFINED ANGLE

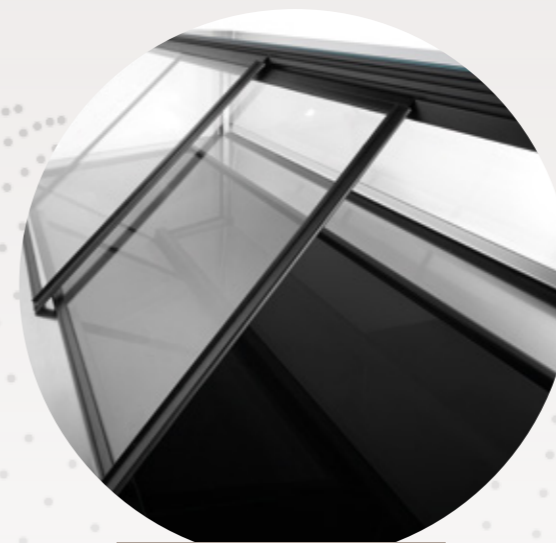

CHIUSURA POSTERIORE
CON SCORREVOLI IN PLEXIGLASS

BACK CLOSURE IN SLIDING
PLEXIGLASS DOORS

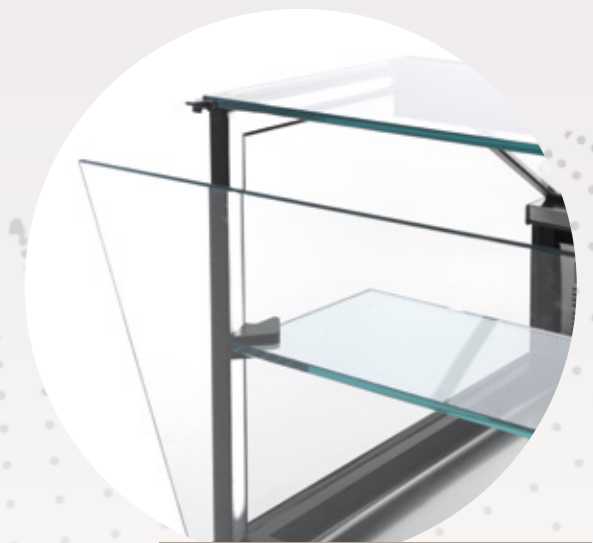

APERTURA VETRO ANTERIORE

GLASS FRONT OPENING



Stiltek si riserva il diritto di apportare modifiche ai prodotti illustrati in questo catalogo in qualunque momento senza l'obbligo di preavviso.

Stiltek reserves the right to make changes to the products shown in this catalogue at any time without notice



Stiltek - divisione di Frigomeccanica
Via del Progresso 10, 64023 Mosciano S. Angelo (TE) - Italy
Tel. +39 085/80793650 Fax +39 085/80793590 www.stiltek.it info@stiltek.it